

Read before installing the recommendations and warnings on the last page of this manual.

### Vibra Switch “S”

#### LEVEL SWITCH



Manufactured by:

 **KLAY-INSTRUMENTS B.V.**

[www.klay-instruments.com](http://www.klay-instruments.com)

Nijverheidsweg 5  
P.O. Box 13  
Tel: +31-521-591550  
Fax: +31 -521-592046

7991 CZ DWINGELOO  
7990 AA DWINGELOO  
The Netherlands  
E-mail: [info@klay.nl](mailto:info@klay.nl)

## CONTENTS

	<b>SECTION</b>	<b>PAGE</b>
1	Introduction	3/8
2	Technical data	3/8
2.1	General	3/8
2.2	3 Wire DC output, to drive relays PLC-S	4/8
2.3	Accessories	4/8
2.4	Ordering code	5/8
2.5	Pressure- and temperature diagrams	5/8
2.6	Response time to free state	5/8
3	Installation	6/8
3.1	Switching point and Switch differential	6/8
4	Electrical connections	7/8
4.1	Connection Terminal output 3 (PNP)	7/8
4.2	Description: Terminal output, Dipswitch and Status LED	7/8
5	Adjustment	8/8
6	Maintenance	8/8
7	Precautions and Warnings	8/8

## 1. Introduction

The Vibra-Switch "S" is a robust microprocessor controlled level switch based on the "tuning fork" principle. The piezoelectric crystal is brought into vibration, and records the difference in resonance frequency, the output status changes when there is a significant difference in the resonance frequency. When the tuning fork is covered by product, the frequency changes. This change is detected by the electronics and converted into a switching command.

- i** The Vibra Switch "S" is compact and robust and is suitable for all liquids. The unique frequency of the vibrating fork level switch creates an insensitivity for vibrations in the process.

The "density" on which the level switch has to operate is selectable by a switch. If the level switch is used on high viscosity fluids, the mounting position is very important. The position of the tuning forks have to be in such way the fluid can easily drop of the tuning fork.

A marking on the hexagonal neck on top of the process connection shows the position of the tuning forks. The stainless steel electronics housing can be turned around independently from the tuning forks.

## 2 TECHNICAL DATA

### 2.1 GENERAL

Vibra-Switch "S"	
Maximum pressure	40 bar
Probe length	0,50 till 3 meters
Material wetted parts	AISI 316
Liquid temperature range	See table in 2.6 and diagrams
Ambient temperature	See table in 2.6 and diagrams
Process temperature	-40 till +90°C
Ambient temperature	-40 till +70°C
Liquid density	≥ 0.7 kg/dm <sup>3</sup> ≥ 1.0 kg/dm <sup>3</sup>
Liquid viscosity	≤ 10.000 mm <sup>2</sup> /s (c St)
Response time	2 seconds
Output mode indication	Status LED

## 2.2 3-WIRE DC OUTPUT, TO DRIVE RELAYS OR PLC-S

Version	3 wire DC	
	Output 3	
Cable gland	PG 9	(Optional M12 connector)
Protection Grade	IP 66	(Optional IP 68)
High/low mode setting	Switch selectable	
Density	Switch selectable	
Output	PNP	
Output protection	Reverse polarity, overvoltage and short circuit protection	
Supply voltage	12 - 40 Vdc	
Consumption	< 0,6 W	
Voltage drop in switched-on state	< 4,5 Vdc	
Current load	max. continuous	$I_{\max} = 350 \text{ mA DC} / U_{\max} = 40 \text{ Vdc}$
Residual current (in switched-off state)	< 100 $\mu\text{A}$	

## 2.3 ACCESSORIES

Various hygienic process connections are available (milk coupling, tri-clamp, etc.) The standard process connection is 1" BSP thread. Various weld-on nipples, including the standard 1" BSP weld- on nipple are available on request. The 1" BSP hygienic weld-on nipples are available in two versions:

- Diameter  $\varnothing$  65 mm (article no. 10197)
- Diameter  $\varnothing$  48 mm (article no. 10189)

## 2.4 ORDERINGCODE

VIBRA SWITCH S

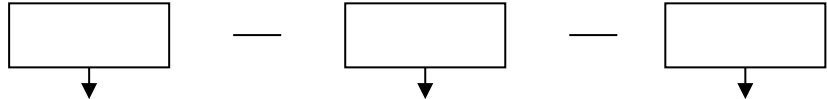

VSS	PROCESCONNECTION	CODE	LENGTH	CODE	OUTPUT	CODE
	1" BSP (Standard)	S	Short (47 mm)	47	3-wire (PNP)	3
	Milk coupling DN 40 (DIN11851)	M(40)	Standard (100 m)	100		
	Milk coupling DN 50 (DIN11851)	M(50)	0,2 till 3 meter	200..3000		
	Tri clamp (2")	L(2")				
	Flange (Specify size)**	F				
	Other connections	X (...)				

M40, M50, L(2") and flanged versions are standard screwed into the 1" BSP process connection. Welded versions can be delivered on request.

## 2.5 PRESSURE AND TEMPERATURE DIAGRAMS

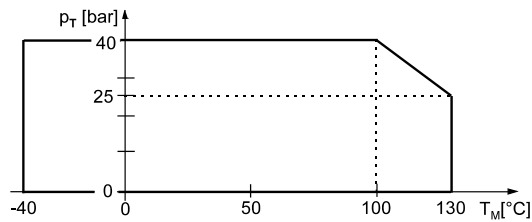

Voor alle modellen

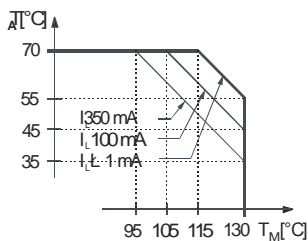

Voor 3-draads DC modellen (IL) weerstand stroom

## 2.6 RESPONSE TIME DIAGRAM WHEN GETTING FREE

Response time [S]

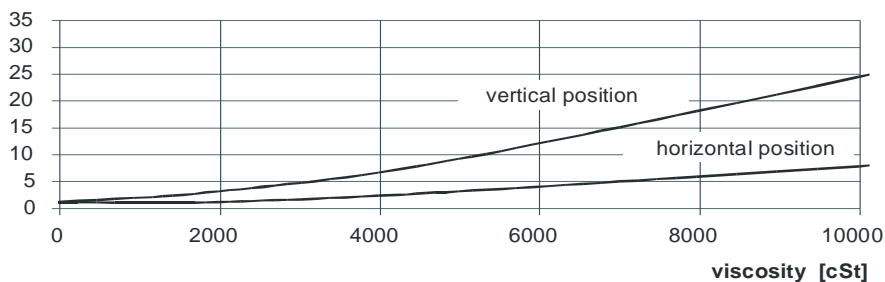

### 3. INSTALLATIE

For positioning the tuning forks, use the marking on the hexagonal neck. Use a Teflon (PTFE) tape to aid the positioning of the fork-tine. If the fork-tine position is irrelevant, use the sealing ring provided. To mount in the mandrel use the provided o-ring and possibly the sealing ring.

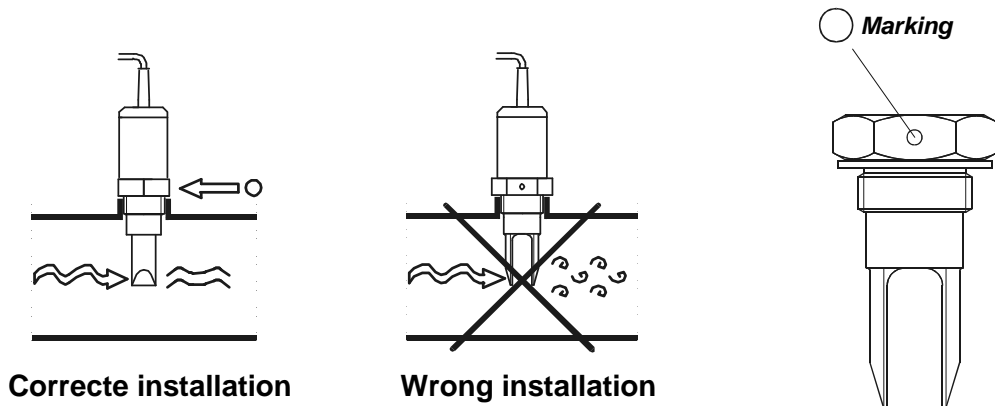

Correcte installation

Wrong installation

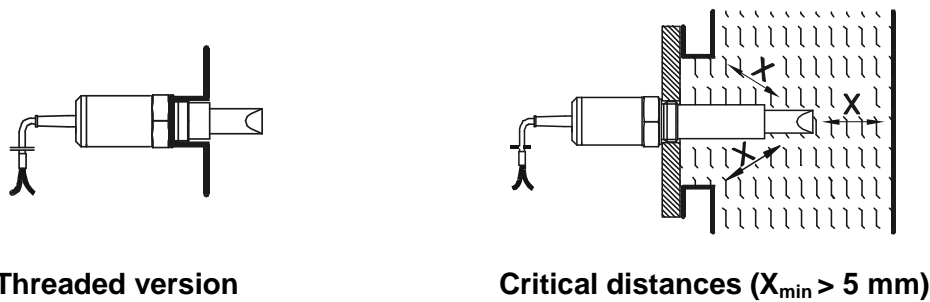

Threaded version

Critical distances ( $X_{min} > 5 \text{ mm}$ )

#### Installing options

For applications with a medium with a relative normal density, all mounting positions are shown to the right as possible.

For applications with a high density, it is recommended to mount the "tuning forks" only vertically (top mount).

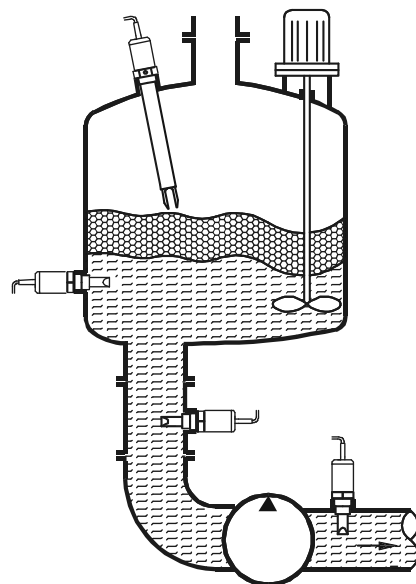

### 3.1 SWITCHING POINT AND SWITCH DIFFERENTIAL (HYSTERESIS)

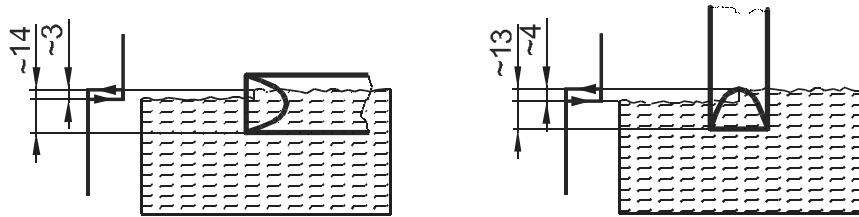

**(For water at 25°C)**

Both the switching point and the switching differential are light depending on the density of the fluid and the mounting position. Be aware of the mounting position of the tuning forks with respect to the direction of flow of the liquid.

## 4 ELECTRICAL CONNECTIONS

### 4.1 CONNECTION TERMINAL OUTPUT 3 (PNP)

**Power Supply: 12 - 40 Vdc**

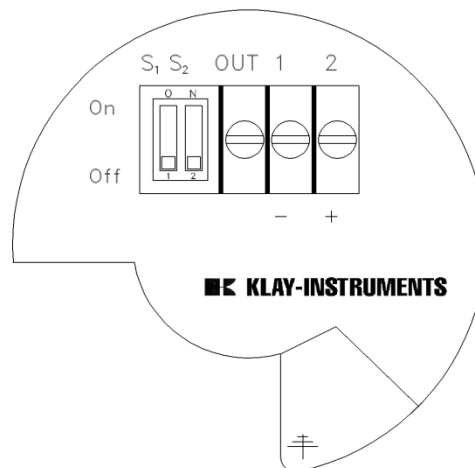

### 4.2 DESCRIPTION CONNECTION TERMINAL, DIPSWITCH AND STATUS LED

Terminal 2	: +
Terminal 1	: -
Terminal out	: PNP
S1 (on)	: Output n.c.
S1 (off)	: Output n.o.
S2 (on)	: High density
S2 (off)	: Low density
Led green	: Output n.o.
Led red	: Output n.c.

## 5. ADJUSTMENT

Check the connection of the wires and the position of vibrating probes. After connection and power up the level switch is operational.

Operating diagram of the Vibra Switch "S":

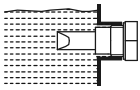
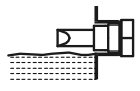
Power supply	Probe	Function	Status LED	S1	Output
ON	 Immersed	High level	Red	Off	24 Vdc
		Low level	Green	On	0 Vdc
	 Free	High level	Green	Off	0 Vdc
		Low level	Red	On	24 Vdc

## 6 MAINTENANCE

The Vibra-Switch "S" is maintenance free. If the "tuning forks" needs to be cleaned of residual medium, this should be done very carefully without exerting mechanical force on the "tuning forks"!



## PRECAUTIONS and WARNINGS

- Check if the specifications of the VSS meets the process conditions.
- In order to obtain an as accurate as possible to operate VSS, the location of the tuning fork is very important. **DO NOT** use the tuning fork in- or near filling or discharging pipes, but place it in the tank wall, because currents caused by a pump, may affect the accuracy.
  - Also make sure that automatic cleaning (eg spray ball cleaning) or hand cleaning of tanks, the water cannot damage the tuning fork or bend.
  - The tuning fork will not work correctly if there are air bubbles present in the system.

### Damaging the tuning fork is not covered under warranty.

- When the tuning fork is placed in pipelines , then it is necessary to take following into account:
- Rapid closing valves in combination with high flow velocity will cause water hammer(spikes) and can damage the tuning fork. **DO NOT** mount a tuning fork near such valves, always place a few pipe bends away up or down stream (avoid suction).
- Remove the tuning fork out of the package only just before installation to prevent damage to the instrument. Do not hold or carry the instrument on the side of the tuning fork.
- Prevent any bending and damaging to the tuning fork.
- As soon as the wiring is brought inside through the PG cable gland and connected to the terminal board, make sure the cable gland is tightly fixed, so that moisture cannot enter into the electronic housing.
- Do not remove or adjust the venting.  
If the ambient conditions are very wet, we advise to use a venting through the cable. A special vented cable can be delivered on request. (The normal venting will be removed)
- Prevent direct exposure to waterjets (cleaning)
- The cover must be fully engaged, so that moisture cannot ingress into the electronic housing. The cover must only be capable of being released or removed with the aid of a tool.
- **WARRANTY:** The warranty is 1 year from delivery date.  
Klay Instruments B.V. does not accept liability for consequential damage of any kind due to use or misuse of the VSS. Warranty will be given, to be decided by the manufacturer. Equipment must be shipped prepaid to the factory on manufacturers authorization.
- **NOTE:** Klay Instruments B.V. reserves the right to change its specifications at any time, without notice. Klay Instruments B.V. is not an expert in the customer's process (technical field) and therefore does not warrant the suitability of its product for the application selected by the customer.

Manufactured by:

 **KLAY-INSTRUMENTS B.V.**

[www.klay-instruments.com](http://www.klay-instruments.com)

Nijverheidsweg 5  
P.O. Box 13  
Tel: +31-521-591550  
Fax: +31 -521-592046

7991 CZ DWINGELOO  
7990 AA DWINGELOO  
The Netherlands  
E-mail: [info@klay.nl](mailto:info@klay.nl)