

Make sure you thoroughly understand the contents of this manual before installing and using this level switch.

Vibra Switch “C” Level Switch



Manufactured by:

 **KLAY-INSTRUMENTS B.V.**

www.klay-instruments.com

Nijverheidsweg 5
P.O. Box 13
Tel: +31-521-591550
Fax: +31 -521-592046

7991 CZ DWINGELOO
7990 AA DWINGELOO
The Netherlands
E-mail: info@klay.nl

CONTENTS

SECTION		PAGE
1	Description	3/6
2	Technical data	3/6
3	Wire DC output, to drive relays PLC-S	4/6
4	Accessories	4/6
5	Installation	4/6
5.1	Switching point and switch differential	5/6
6	Electrical connections	6/6
7	Adjusting	6/6
8	Maintenance	6/6
9	Warranty	6/6

1. DESCRIPTION:

The Vibra-Switch "C" is a robust and compact **micro processor based** level switch based on a vibrating probe. The piezo crystal is excited and kept in resonance by an electronic circuit. The process liquid, when reaching the probes changes the frequency of the vibration. The vibration frequency in a liquid is lower than in air or gas.

The Vibra Switch "C" is suitable for all kind of liquids. Due to the high vibration frequency combined with the very rugged probe, the function will not be influenced by turbulence, air bubbles or system vibration.

If the level switch is used on high viscosity fluids, the mounting position is very important. The position of the tuning forks have to be so that the fluid easily drops of.

A marking on the hexagonal neck on top of the process connection shows the position of the tuning forks.

2. TECHNICAL DATA

Vibra-Switch "C"	
Maximum pressure	40 bar
Probe length	47 mm up to 3 meters
Material wetted parts	AISI 316
Liquid temperature range	-10.....+90°C (tested) -40.....+100°C (limits)
Ambient temperature	0.....+70°C (tested) -40.....+70°C (limits)
Liquid density	≥ 0.7 kg/dm³
Liquid viscosity	≤ 10.000 mm²/s (c St)
Respon time	2 seconds
Output mode indication	Status LED (<u>not</u> with the cable version, output 4)
Hirschmann connector	4-Pole (Standard) Polyamide
M12 Connector	Option (extra price)

3. 3-WIRE DC OUTPUT, TO DRIVE RELAYS OR PLC:

Version	3 wire DC	
Cable gland	PG 9	
Protection Grade	IP 65	IP 68 (with cable version)
Output	PNP, 3-wire	
Output protection	Over voltage and short circuit protected Thermal protection	
Supply voltage	12 ... 40 Vdc	
Consumption	< 0,35 W	
Voltage drop in switched-on state	< 4,5 Vdc	
Current load (maximum values)	$I_{\max} = 350 \text{ mA DC} / U_{\max} = 40 \text{ Vdc}$	
Residual current (in switchedoff state)	< 100 μA	

4. ACCESSORIES:

Various hygienic process connections are available (milk coupling, tri clamp, etc).

The standard process connection is 1" BSP thread.

Various weld-on nipples, also the standard sanitary 1" BSP weld- on nipple are available on request.

The 1" BSP hygienic weld-on nipples are available in two versions, $\varnothing 65 \text{ mm}$ (article no. 10197) and $\varnothing 48 \text{ mm}$ (article no. 10189).

5. INSTALLATION:

Avoid mechanical damage.

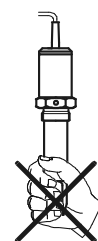
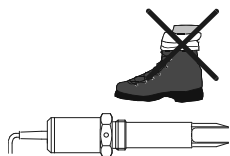
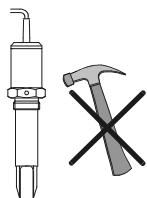

For positioning the tuning forks, use the marking on the hexagonal neck. Use a TEFLON (PTFE) tape to aid the positioning of the fork-tine.

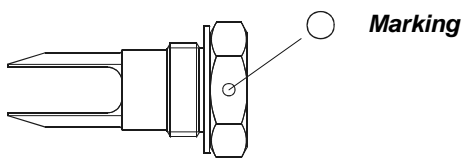

Low Viscous liquids

In applications where the medium is **not** viscous, all mounting positions as shown on the right are possible.

High Viscous fluids.

On applications with viscous media is recommended for the "tuning fork" only vertically to mount.

Installing options

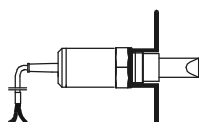
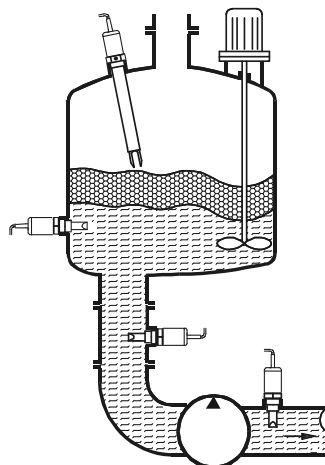

Threaded version

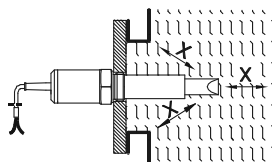

Critical distances ($x_{min} > 5 \text{ mm}$)

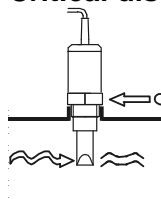
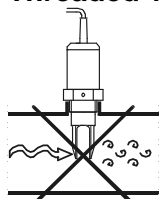

5.1 SWITCHING POINT AND SWITCHING HYSTERESIS:

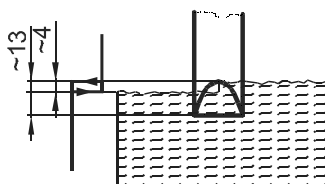
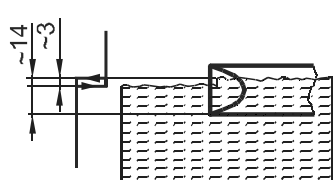

(For water at 25°C)

Switching point as well as the switch differential depends on liquid density and mounting position. Fork-tunes must be parallel to the direction of flow.

6. ELECTRICAL CONNECTIONS:

Output: 3

PNP mode: N.O. out	PNP mode: N.C. out
1 = +	1 = -
2 = -	2 = +
3 = PNP	3 = PNP

Output: 4 (with mounted cable)

PNP mode: N.O. out	PNP mode: N.C. out
Red = +	Red = -
Bleu = -	Bleu = +
Yellow= earth	Yellow= earth
Black = PNP (N.O.)	Black = PNP (N.C.)

7. ADJUSTMENT:

Check the connection of the wires and the position of vibrating probes. After connection and power up the level switch is operational.

Operating diagram of the Vibra Switch "C":

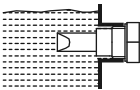
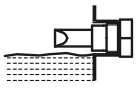
Power supply	Probe	Operating mode	Status LED	Output
ON	 Covered	High level	Red	24 Vdc
		Low level	Green	0 Vdc
	 Free	High level	Green	0 Vdc
		Low level	Red	24 Vdc

8. MAINTENANCE and REPAIR:

The Vibra Switch "C" is maintenance free. If the "tuning fork" should be cleaned of laggard medium, it should be done very carefully without mechanical force to the "tuning fork"!

9. WARRANTY:

The warranty is 1 year from delivery date.

Klay Instruments B.V. does not accept liability for consequential damage of any kind due to use or misuse of the Vibra Switch.

Warranty will be given, to be decided by the manufacturer.

The Level Switch must be shipped prepaid to the factory on manufacturer's authorization.

The tuning forks should not be damaged.

NOTE:

Klay Instruments B.V. reserves the right to change its specifications at any time, without notice.